

Airside Communication Manual



THIS DOCUMENT AND THE MATTERS CONTAINED HEREIN ARE PRIVILEGED AND CONFIDENTIAL AND REMAIN THE SOLE PROPERTY OF MBJ AIRPORTS LTD. ANY OTHER DISTRIBUTION, COPYING OR DISCLOSURE IS STRICTLY PROHIBITED

Table of Contents

Communication One	3
Communication Systems	
Introduction to Communication	3
Communication Systems.....	3
Elements of a Communication System	4
Barriers to Effective Communication	4
Communication in Civil Aviation	5
Communication Two	6
Phonetics	
Alpha Phonetics.....	6
Numeric Phonetics	7
Communication Two Worksheet	9
Communication Three	10
Standard Phraseology for Radio Contact	
ATC Phraseology	10
Standard Words and Phrases	11
Call Signs	12
Vehicles.....	12
Guidance for Radio Contact	13
Crossing Runway	13
Aerodrome Environment	14
Aerodrome Geographical Data	
Definitions.....	14
Aerodrome Geographical and Administrative Data	18
Sangster Runway	20
Calculation of Active Runway.....	21
Aerodrome Environment Three	22
Aerodrome Markings	
Runway and Threshold Markings	22
Taxiway Markings	23
Holding Point Markings	24
Visual Aids Denoting Restricted Use Area	24
Non Load Bearing Surfaces	25

Aerodrome Environment Four	28
<i>Aerodrome Lighting and Signals</i>	
Approved Aeronautical Lights.....	28
Runway Threshold Lights.....	28
Runway End Lights	30
Runway Centerline and Touchdown Zone Lights.....	31
Stopway Lights.....	31
Taxiway Lights	31
Approach Lighting	32
Visual Approach Slope Indicator Systems	34
Aerodrome Beacon	35
Light Mountings.....	35
Light Intensity Control	35
Local Operation of Aerodrome Lighting.....	36
Aerodrome Markings and Lighting	37
 Aerodrome Environment Five	 38
<i>Objects within Aerodrome</i>	
Objects Within Specified Areas	38
Objects to be Marked or Lit	38
Lighting of Objects	39
Visual Aids to Landing.....	42
 Aerodrome Environment Six	 43
<i>Traffic on the Manoeuvring Area</i>	
Movement on Manoeuvring Area.....	43
Signaling Lamps.....	43
ATC Light Signals	45
 Aerodrome Operations Two	 46
<i>Vehicle Safety</i>	
Safety Requirement for Vehicle and Equipment.....	46
Traffic of Persons and Vehicles on Aerodrome	47

COMMUNICATIONS ONE

INTRODUCTION TO COMMUNICATIONS

General

Communication is defined as, **the transfer of information from one party to another and feedback confirming that the information has been received.** You will note that only the **successful** transfer of information is called **communication**. If a person tries to pass information that is understood differently from the intent of the message then communication has not taken place.

In communicating, we must therefore seek to engage **effective communication – an exercise which produces a situation in which both sender and receiver have the same understanding of the information transmitted.** Effective communication is absolutely necessary for safe and efficient operations within the manoeuvring area.

Effective communications technique is an essential item, without which there can be no transfer of information, or at best only a partial transfer. We communicate in many ways, with words, pictures, body language (facial expressions, hand gestures, etc.). The more senses stimulated the more effective communications will be.

Some means of communication include:

- the spoken word
- the written word
- diagrams and pictures
- sound codes (Morse, etc.)
- signals (light)
- body language

Communication Systems

Technology affords communication via communications systems. These are devices used for transmission and reception of information over long distances. Examples of these are:

- telephone
- television
- commercial radio
- Aeronautical Telecommunication System

Elements of a Communication System

Communication is the sending of messages, which evokes responses. It involves the use of the five senses, mainly sight and hearing, and the three methods most often used are written, oral and visual.

The basic elements of communication are:

- (a) The sender/transmitter/source - originator of the information
- (b) The receiver - receives the information
- (c) The message – the information
- (d) The channel/ transmission/link, the physical path via which the information is transferred
- (e) Feedback – interpretation of the information

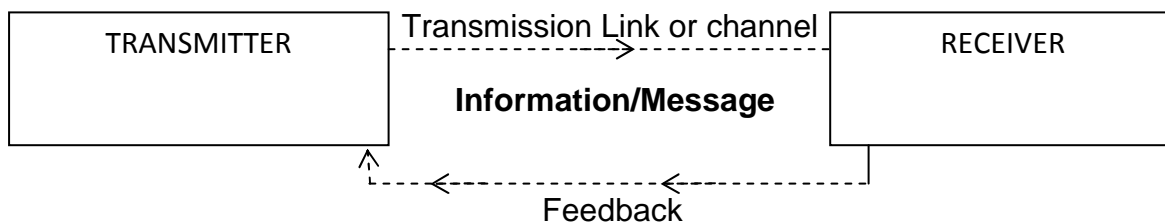

Barriers to Effective Communications

The ability to communicate with others is often taken for granted. What if there was a barrier (noise) to our efforts in trying to communicate?

Throughout all these elements, interference exists, called **noise**. Noise is information, either **literal** (talking in the background) or **psychological** (thinking about chores at home), that interferes with the accurate reception of the communication of the message, in other words it keeps a message from being understood and achieving its intended effect. Without noise, all messages would be communicated with sublime accuracy. But noise is always present. Communicating accurate messages involves minimizing both external and psychological noise.

These barriers could take the form of:

- language differences
- speech difficulty
- unfamiliarity with codes or signals used
- noise
- ambiguity
- mind wandering
- distance
- stereotyping
- physical environment such as wind, etc.

Communication in Civil Aviation

In Civil Aviation, we are concerned with two broad categories of communication systems, namely the **Cable System** and the **Radio (Wireless) System**. The services associated with these systems are collectively referred to as the Aeronautical Telecommunication Service

The **Aeronautical Telecommunication Service** is divided as follows: -

1. The **Aeronautical Mobile Service (AMS)** has to do with radio telecommunications between aircraft and Air Traffic Control (ATC). It makes it possible for aircraft to communicate with ATC and other ground-based agencies.
2. The **Aeronautical Broadcast Service (ABS)** has to do with the general broadcast of aeronautical information, for example, weather, runway in use, essential aerodrome conditions, etc. on specific broadcast frequencies from which interested parties may obtain the information.
3. The **Aeronautical Radio Navigational Service (ARNS)** has to do with radio navigational aids, such as Very High Frequency Omni-Directional Range (VOR), Non-Directional Radio Beacon (NDB), Instrument Landing System (ILS), Microwave Landing System, etc.
4. The **Aeronautical Fixed Service (AFS)** has to do with communications between aeronautical fixed stations on the surface, such as Air Traffic Control (ATC), Meteorological Office (MET), MBJ Operations vehicles on the aerodrome and Airline companies. The Aeronautical Fixed Telecommunication Network (AFTN) is used in the provision of this service.

COMMUNICATIONS TWO

ALPHA PHONETICS

It has been determined that the incidence of misunderstanding between pilots, aerodrome users and air traffic services personnel have been responsible for a number of dangerous situations.

The high safety and efficiency needs of aviation demands that due care and close attention is paid to verbal communication. Air traffic control, because of occasional poor radio reception, unfamiliarity, accents etc. sometimes requires aviation personnel to spell names of locations or instruction, etc.

The objective of the phonetic alpha/numeric is to standardize the way in which letters and numbers are enunciated in order to reduce misunderstanding between aviation personnel.

Syllables to be emphasized are underlined:

Letter	Word	Pronunciation
A	Alpha	<u>AL</u> FAH
B	Bravo	<u>BRAH</u> VOH
C	Charlie	<u>CHAR</u> LEE or <u>SHAR</u> LEE
D	Delta	<u>DELL</u> TAH
E	Echo	<u>ECK</u> OH
F	Foxtrot	<u>FOKS</u> TROT
G	Golf	GOLF
H	Hotel	HOH <u>TELL</u>
I	India	<u>IN</u> DEE AH
J	Juliet	<u>JEW</u> LEE <u>ETT</u>
K	Kilo	<u>KEY</u> LOH
L	Lima	<u>LEE</u> MAH
M	Mike	MIKE
N	November	NO <u>VEM</u> BER
O	Oscar	<u>OSS</u> CAH
P	Papa	PAH <u>PAH</u>
Q	Quebec	KEH <u>BECK</u>
R	Romeo	<u>ROW</u> ME OH
S	Sierra	SEE <u>AIR</u> RAH
T	Tango	<u>TANG</u> GO
U	Uniform	<u>YOU</u> NEE FORM or <u>OO</u> NEE FORM
V	Victor	<u>VIK</u> TAH
W	Whiskey	<u>WISS</u> KEY
X	X-ray	<u>ECKS</u> RAY
Y	Yankee	<u>YANG</u> KEY
Z	Zulu	<u>ZOO</u> LOO

NUMERIC PHONETICS

When transmitting numbers, the syllables printed in capital letters are to be stressed.

Numeral Element	Pronunciation
0	ZE-RO
1	WUN
2	TOO
3	TREE
4	FOW-er
5	FIFE
6	SIX
7	SEV-en
8	AIT
9	NIN-er
Decimal	DAY-SEE MAL
Hundred	HUN-dred
Thousand	TOU-SAND

All numbers except whole hundreds, whole thousands, and combinations of thousands and whole hundreds shall be transmitted by pronouncing each digit separately. Whole hundreds and whole thousands shall be transmitted by pronouncing each digit in the number of hundreds or thousands followed by the word HUNDRED or THOUSAND as appropriate.

Combinations of thousands and whole hundreds shall be transmitted by pronouncing each digit in the number of thousands followed by the word THOUSAND and the number of hundreds followed by the word HUNDRED.

Examples:

Number	Transmitted as	Pronounced as
10	ONE ZERO	WUN ZE-RO
100	ONE HUNDRED	WUN HUN-dred
2500	TWO THOUSAND FIVE HUNDRED	TOO TOU-SAND FIFE HUN-dred
10 000	ONE ZERO THOUSAND	WUN ZE-RO TOU-SAND
47 162	FOUR SEVEN ONE SIX TWO	FOW-er SEV-en WUN SIX TOO

Transmission of Time

Normally, only the minutes past the hour are required. The hour should be included if there is any possibility of confusion.

Time	Transmitted as	Pronounced as
0702	ZERO TWO or ZERO SEVEN ZERO TWO	ZE-RO TOO or ZE-RO SEV-en ZE-RO TOO
1900	ONE NINE ZERO ZERO	WUN NIN-er ZE-RO ZE-RO
1055	FIVE FIVE or ONE ZERO FIVE FIVE	FIFE FIFE or WUN ZE-RO FIFE FIFE

COMMUNICATIONS TWO WORKSHEET

Express the following in phonetic form:

TOWER

VEHICLE

CROSS

RUNWAY

Write the pronunciation for these numbers

10

35

4689

251

COMMUNICATIONS THREE

ATC PHRASEOLOGY

Communication in the Air Traffic Services (ATS) involves dialogue via radiotelephone, telephone or the teleprinter. This dialogue involves the transmission of information, which requires accuracy, speed and clarity of intent. Communication within the air traffic services sees the exchange of information between: -

- A) Air Traffic Services personnel and pilots
- B) Air Traffic Services personnel
- C) Air Traffic Services personnel and the Airport Operator

Notwithstanding the fact that communication in international aviation has been standardized by the use of one language, (English), the exchange involves persons of different languages, cultures and customs, a situation which has the potential for great confusion, inefficiency in the use of transmission time or worse, disaster. The international aviation community through I.C.A.O., in pursuance of its objective to be safe, orderly and expeditious, has developed a standard in the pronunciation, use and meaning of words and phrases commonly encountered in air traffic services communications, called standard phraseology.

Constant attention to correct and concise phraseologies and proper procedures at all times will result in their becoming automatic which can only raise the general level of quality of aeronautical radiotelephony and consequently improve the safety of operations both in the air and on the ground.

While great effort was made to coin standard phraseologies to cover most operating scenarios, it is not practicable to give examples covering every conceivable situation which may arise. The use of non-standard procedures and phraseology can cause misunderstanding. Incidents and accidents have occurred in which a contributing factor has been the misunderstanding caused by the use of poor phraseology. Air traffic services personnel are therefore expected to use the basic rules of communication (clear and concise) in coining phraseologies for any situation not covered.

This lesson looks at a few commonly used words and phrases along with their meanings.

Standard words and Phrases

The following words and phrases shall be used in radiotelephony communications as appropriate and shall have the meaning given below.

Word/Phrase	Meaning
ACKNOWLEDGE	Let me know that you have received and understood this message
AFFIRM	Yes
APPROVED	Permission for proposed action granted.
BREAK	I hereby indicate the separation between portions of the message. (to be used where there is no clear distinction between the text and other portions of the message.)
BREAK- BREAK	I hereby indicate the separation between messages transmitted to different aircraft in a very busy environment.
CANCEL	Annul the previously transmitted clearance.
CHECK	Examine a system or procedure. (No answer is normally expected.)
CLEARED	Authorized to proceed under the conditions specified.
CONFIRM	Have I correctly received the following ...? Or Did you correctly receive this message?
CONTACT	Establish radio contact with ...
CORRECT	That is correct.
CORRECTION	An error has been made in this transmission (or message indicated).The correct version is...
DISREGARD	Consider that transmission as not sent.
GO AHEAD	Proceed with your message.
HOW DO YOU READ	What is the readability of my transmission?
I SAY AGAIN	I repeat for clarity or emphasis.
MONITOR	Listen out on (frequency)
NEGATIVE	No or Permission not granted or That is not correct.
OVER	My transmission is ended and I expect a response from you. <i>Note.-Not normally used in VHF communications.</i>
OUT	This exchange of transmissions is ended and no response is expected. <i>Note. - Normally used to indicate the end of an exchange of transmissions.</i>
READ BACK	Repeat all, or the specified part, of this message back to me exactly as received.
RECLEARED	A change has been made to your last clearance and this new clearance supersedes your previous clearance or part thereof.
REPORT	Pass me the following information.
REQUEST	I should like to know ..., or wish to obtain ...
ROGER	I have received all of your last transmission. <i>Note.-Under no circumstances to be used in reply to a question requiring "READ BACK" or a direct answer in the affirmative (AFFIRM) or negative (NEGATIVE).</i>
SAY AGAIN	Repeat all, or the following part, of your last transmission.
SPEAK SLOWER	Reduce your rate of speech.
STANDBY	Wait and I will call you.
VERIFY	Check and confirm with originator
WILCO	(Abbreviation for "will comply.") I understand your message and will comply with it.
WORDS TWICE	a) As a request: Communication is difficult. Please send every word or group of words twice. b) As information: Since communication is difficult, every word or group of words in this message will be sent twice

CALL SIGNS

Call signs for aeronautical stations

These are identified by the name of the location followed by the name of the type of unit or service provided, for example

Name of Location	Type of Unit
Sangster	TOWER

Sangster Tower consists of Air control (dealing with the aircraft in the air) and Ground control dealing the aircraft or vehicles on the ground.

Vehicles

The expeditious movement of vehicles plays an essential supporting role in the operation of an aerodrome. Wherever possible the areas in which vehicles and aircraft operate are segregated. There are, however, many occasions when vehicles need to move on the maneuvering area for maintenance purposes or in direct support of aircraft operations.

Procedures governing the movement of vehicles vary widely from aerodrome to aerodrome, but certain factors to be taken into account when driving on an aerodrome are common to all:

- a) aircraft are not as maneuverable as ground vehicles;
- b) The visibility from an aircraft cockpit for ground movement purposes is often restricted compared to that from a ground vehicle.

Therefore, when vehicles are operating in close proximity to aircraft, drivers should be extremely vigilant and comply in full with procedures and ATC instruction.

Correct radio-telephony operating techniques must be observed by all users. It is important that a continuous listening watch is maintained by all drivers on the movement area, not only in case of further instructions from the control tower, but also so that drivers can be aware of the movements, and intended movements, of other traffic, thereby reducing risk of conflict.

Guidelines for Radio Contact

Drivers on first call should identify themselves by their vehicle call sign, state their position and intended destination and when possible, intended route.

The controller, if too busy to give instructions, will reply “standby”. This means that the driver should wait until the controller calls back. The driver shall not proceed until permission is given.

When there is conflicting traffic, the controller may reply “HOLD POSITION”. This means that the driver shall not proceed until the controller calls back with permission. All other replies should contain a clearly defined point to which the driver may proceed; this may or may not be the intended destination. If it is not the intended destination drivers must stop at this point and request permission before proceeding further.

Crossing Runway

Drivers should carefully note the position to which they may proceed, particularly where the intended route involves crossing a runway. Some aerodromes may have procedures that will allow vehicles to proceed to a holding point and then request runway crossing instructions. Under no circumstances shall a driver cross a runway unless positive permission has been given and acknowledged. A runway vacated report shall not be made until the vehicle is clear of the designated runway area, beyond the holding point.

AERODROME ENVIRONMENT

DEFINITIONS

Aerodrome (AD): A defined area on land or water (including any buildings, installations and equipment) intended to be used either wholly or in part for the arrival, departure and surface movement of aircraft

Aerodrome Control Tower: A unit established to provide air traffic control service to aerodrome traffic

Aerodrome Beacon: Aeronautical Beacon used to indicate the location of an aerodrome from the air

Runway: A defined rectangular area on a land aerodrome prepared for the landing and take-off of aircraft.

Taxiway: A defined path on a land aerodrome established for the taxiing of aircraft, and intended to provide a link between one part of the aerodrome and the other.

Apron: A defined area on a land aerodrome, intended to accommodate aircraft for the purpose of : loading or unloading passengers, mail or cargo; fuelling; parking or maintenance

Aircraft Stand: A designated area on an apron intended to be used for parking of aircraft

Manoeuvring Area: That part of an aerodrome to be used for take-off and landing and for the surface movement of aircraft associated with take-off and landing, excluding aprons.

Stopway: A defined rectangular area on the ground at the end of the take-off run available prepared in the event of an abandoned take-off.

Clearway: A defined rectangular area on the ground or water under the control of the appropriate authority selected or prepared as a suitable area over which an aircraft may make a portion of its initial climb.



PREPARED AREAS

Runway End Safety Areas: These should extend beyond either end of the runway strip for at least 90m and should have a width of at least twice that of the associated runway. Their purpose is to provide a cleared and graded area which would reduce the risk of damage to aircraft in the event of an aircraft under-shooting or over-running the runway and facilitate the movement of rescue and fire fighting vehicles.

Clearways: These should begin at the end of the take off run, should not exceed half the take off run available and should extend at least 75 metres on each side of the extended runway centre line.

Stopways: These should be the same width as the runway and should be capable of supporting the aircraft, if necessary, in the event of an abandoned take-off.

Taxiways: These include the following: -

1. Apron taxiways: located on an apron to provide a route through the apron
2. Aircraft stand taxi lane: Used to gain access to stands only (e.g. Taxi lane E and F)
3. Rapid exit taxiway: Connected to the runway at an angle designed to allow aircraft to turn off at higher speeds (e.g. Taxiway B)

The design of taxiways should be such that when the cockpit of an aircraft is over the taxiway centre line the clearance between the outer main wheel and the edge of the taxiway is not less than 1.5 m whether on a straight or curved taxiway

Taxiway shoulder: These should extent symmetrically on each side of the taxiway so that the overall width of the taxiway and its shoulder will vary between 25 m and 44 m. The purpose and characteristics of taxiway shoulders are essentially the same as for Runway shoulders

Apron: Aprons should be provided where necessary for the on and off loading of passengers, cargo and mail as well as for the servicing of the aircraft without interfering with the aerodrome traffic. The total apron area should be adequate to permit the expeditious handling of aerodrome traffic at its maximum anticipated traffic density

Isolated Parking Position: This shall be designated, or the control tower advised of an area or areas suitable, for the parking of an aircraft, which needs to be isolated from the normal airport activity because of unlawful interference or other reason.

This area should be located at the maximum distance practicable and in any case not less than 100 m from other parking positions, buildings or public areas, etc. Care should also be taken that the position is not located over underground utilities such as gas and aviation fuel, and to the extent feasible, electrical or communication cables

At Sangster Airport, this designated area is equidistant between Taxiway B and Taxiway E intersections with Taxiway A

Holding Bay: This is a defined area where aircraft may be held or by-passed to allow the efficient movement of aircraft. The distance between a runway centre line and a holding bay or taxi-holding position will vary between 30 m and 75 m depending on the type of runway.

EXAMPLES OF HOLDING BAY CONFIGURATIONS

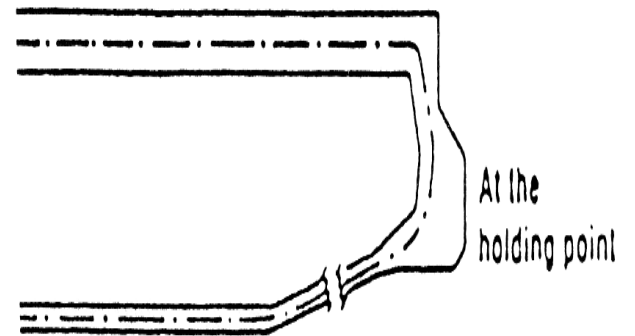
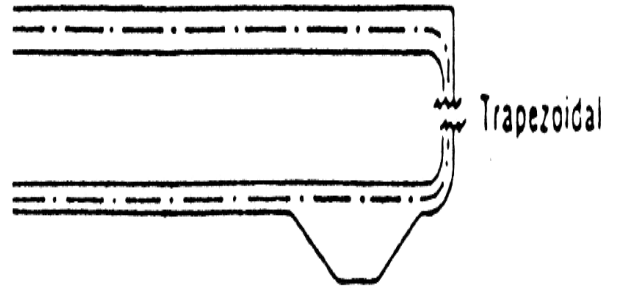
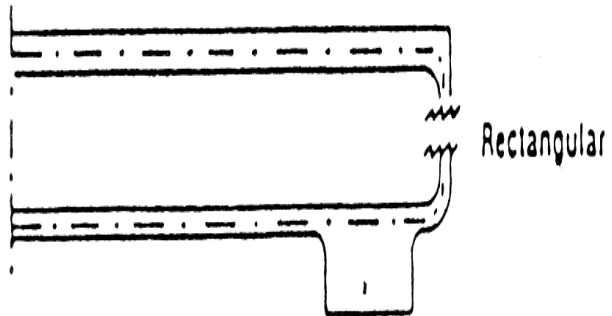

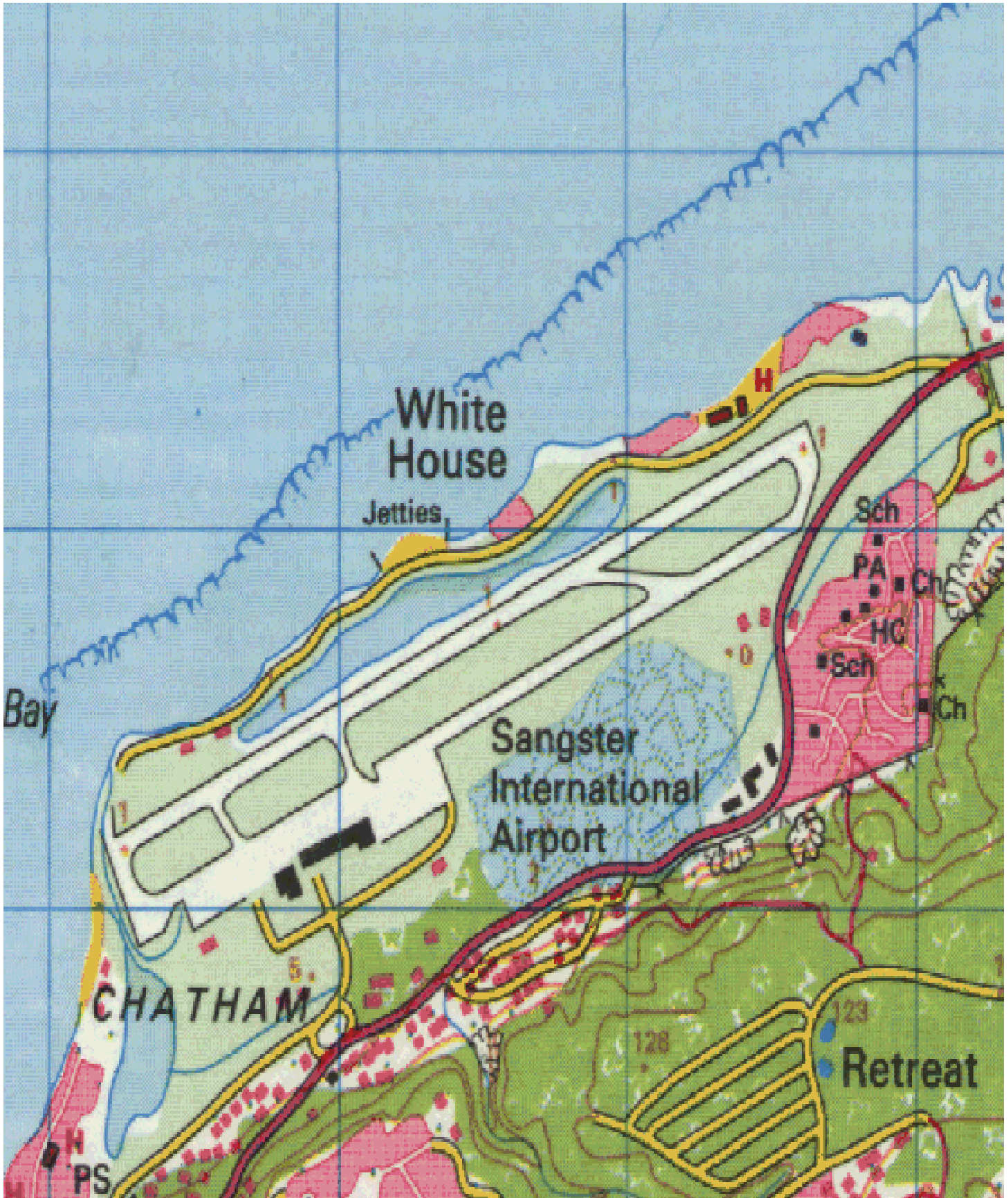

AERODROME ENVIRONMENT

AERODROME GEOGRAPHICAL AND ADMINISTRATIVE DATA

The coordinates and site of Sangster International airport referred to as the Aerodrome Reference Point (ARP) is stated in the chart below, also airport elevation, temperature etc.

ARP coordinates and site at AD	N18°30'13.21" W77°54:48.19"
Direction and distance from (city)	045°, 3NM from Montego Bay City
Elevation	1.2M (4FT)
Reference temperature	33°C
Types of traffic permitted	IFR/VFR
AD administration telephone & fax	Control Tower +(876) 952 3627 Telefax: +(876) 952 6172 Unit Chief +(876) 952 1051 Telefax: +(876) 979 9773

In order to locate the aerodrome aircraft, (depending on the type of flights) needs to fly to special aids on the airfield called navigational aids. The navigational aids available for aircraft at Sangster International Airport (MKJS) consist of the following:

1. DVOR/DME
2. ILS/DME

Facility Identification	Facility Type	Operating freq	Lat/Long coordinates
Sangster SIA	DVOR/DME	115.7 MHZ	Antenna: 18:30.774N 077:55:26.764W
Sangster SIA	ILS/DME	109.5 MHZ	Localiser Antenna: 18:30:33.400N 077:54:01.740W Glide Path Antenna: 18:30:03.100N 077:55:19.750W

IFR - Instrument Flight Rules: These are rules for aircraft to adhere to, in order to fly to an aerodrome, using specific instruments etc. as stated in Annex 2 of the International Civil Aviation Organization (ICAO)

VFR - Visual Flight Rules: These apply to flights conducted in conditions of specified; visibility, cloud ceiling and distance from cloud.

VOR AND DME (VOR - Very High Frequency Omi-directional radio range) and (DME - Distance Measuring Equipment)

The VHF Omni directional (Radio) Range is a ground based radio navigational aid that operates in the frequency band of 112.1 to 117.9 MHz. This frequency band allows interference and static free operations unlike the NDB. The VOR produces between 100 to 200 watts of power to generate signals that give reliable azimuth direction 50 miles at low altitudes, or 150 miles at high altitudes.

ILS – Instrument Landing System: This is the standard ICAO bad weather landing system. This system provides vertical guidance to the centre line of the runway using at least two distance markers to define the runway.

DEFINITIONS

Aerodrome Reference Point (ARP) - The designated geographical location of an aerodrome.

Runway Designator - This consists of a two-digit number eg. 07 or 25

SANGSTER'S RUNWAYS

The Sangster aerodrome consists of two runways (Rwy): RWY 07 & RWY 25. Although there is only one landmass denoting the runway, the runway can be used from either end, thus giving rise to two runways.

Depending on the direction the aircraft is landing it is either landing on RWY 07 or RWY 25. These numbers written on the runway is called the runway designator and this is derived by using or adjusting the digits of its magnetic direction as follows:-

RWY Magnetic Direction	RWY Number
070° M	07
250° M	25

The choice of which runway to use depends on the following factors:

- a. Prevailing wind
- b. Type of aircraft
- c. Effective length of runway
- d. Traffic situation
- e. Available approach aid(s)
- f. Noise abatement procedures
- g. Preferred flight path procedures
- h. Taxiing distance to or from runway
- i. Weather phenomena (turbulence, position of sun, wind shear.)

Prevailing wind

It is best for an Aircraft to land or take-off into the wind so as to assist landing or taking-off requirements. So the runway chosen (the active runway) will be the one most nearly aligned into the wind.

For example:

wind direction of $> 340^\circ$ to $< 160^\circ$ use RWY 07
wind direction of $> 160^\circ$ to $< 340^\circ$ use RWY 25

To calculate the cut-off points add and subtract 90° degrees from either runway direction.

Calculation of active runway

$$070^{\circ} - 90^{\circ} = 340^{\circ} \quad \text{and} \quad 070^{\circ} + 90^{\circ} = 160^{\circ}$$

or;

$$250^{\circ} + 90^{\circ} = 340^{\circ} \quad \text{and} \quad 250^{\circ} - 90^{\circ} = 160^{\circ}$$

Type of aircraft & Effective length of runway: different types of aircraft require differing runway length, so the available landing distance or take-off run available will affect the decision of which runway is used at a particular time.

Traffic situation: traffic density, type of approaches and expedition of traffic is a factor to consider when choosing active runway.

Available approach aid(s): controllers have to bear in mind the available navigational aids at Sangster Aerodrome and which runway would best facilitate aircraft making approaches to the airfield.

Noise abatement procedures: there are certain areas near to the airport which are considered as noise sensitive areas, such as Hotels or residential. To prevent discomfort caused by aircraft noise and to comply with the procedures put in place for noise abatement it might be best to use a particular runway.

Preferred flight path procedures and Weather phenomena: the extent to which the alignment of the runway will facilitate the provision of approaches conforming to the required approach surface specifications. Attention should be paid in particular to whether the aerodrome should be used in all meteorological conditions or only in good weather conditions, and whether it is intended for use by day and night, or only by day.

Taxiing distance to or from runway: if the aircraft has to taxi a long way from the runway to the apron it takes up more taxiway usage time, and this might complicate the Ground controller traffic, as well as, some companies have a restriction on the permissible distance their aircraft should taxi and this may be to assist in fuel conservation etc.

AERODROME ENVIRONMENT THREE

AERODROME MARKINGS

Runway and Threshold Markings

- All Runway markings are white

Threshold

- The beginning of that portion of the runway usable for landing
- Threshold markings shall be provided at the threshold of a paved instrument runway and of a paved non-instrument runway where such runway is intended for international commercial air transport
- Threshold markings should be provided as far as practical at the threshold of an unpaved runway

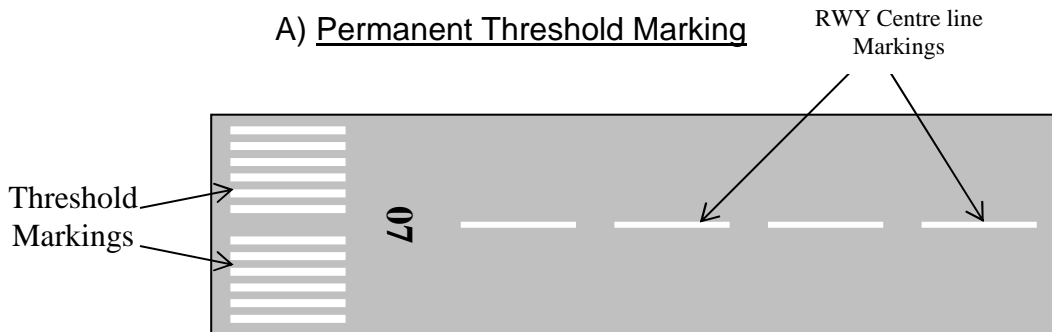

B) Displaced Threshold Markings

- A displaced threshold is one that is not located at the extremity of a runway (*Permanently or temporarily*)

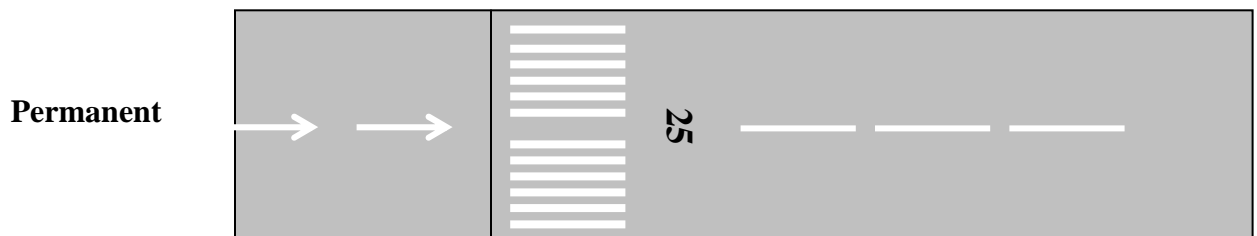

Temporary

C) Touchdown Zone

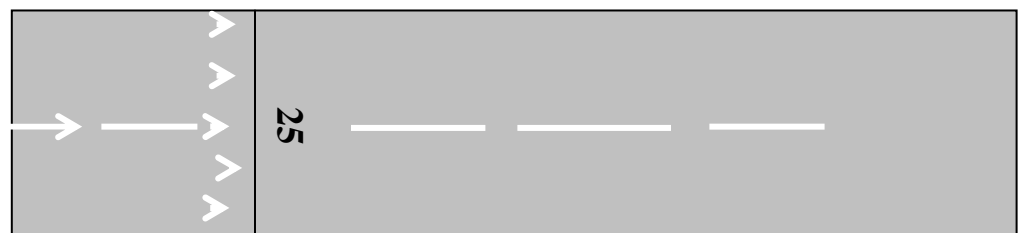

- The portion of runway, beyond the threshold, where it is intended landing airplanes first contact the runway.
- The Touchdown Zone consists of Fixed Distance markings and Aiming Point markings as indicated below
- Touchdown markings shall be provided in the touchdown zone of a paved precision approach runway, and should be provided in respect of a paved non-precision runway where additional conspicuity of the touchdown zone is desirable

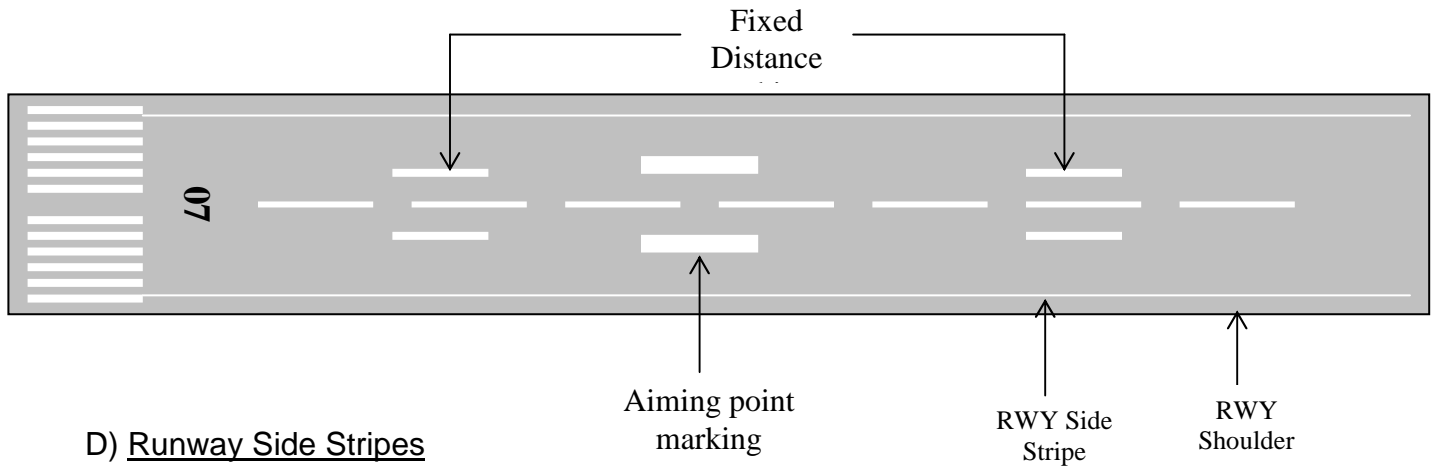

- Runway Side Stripe markings shall be provided between the threshold of a paved runway where there is a lack of contrast between the runway edges and the shoulder or the surrounding terrain

Taxiway Markings

- All Taxiway markings are Yellow

A) Taxiway guideline marking

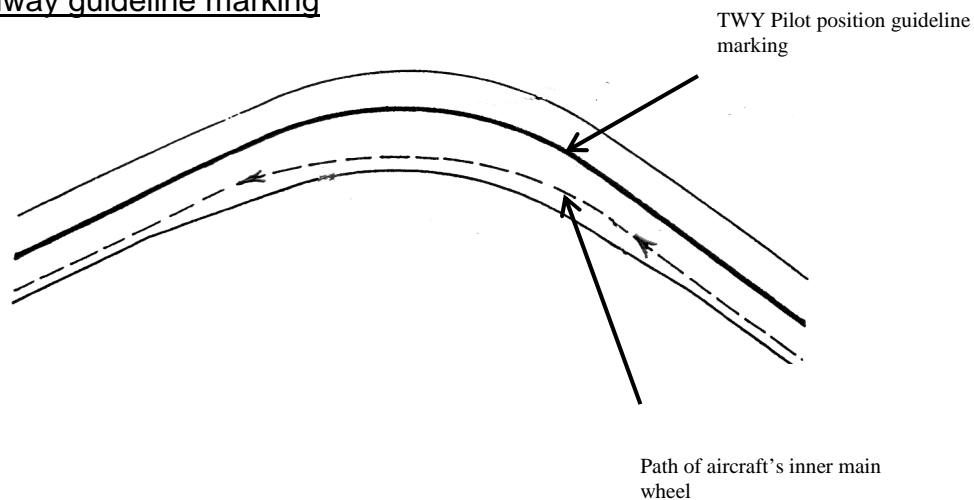

B) Holding Point Markings

Taxiway/Runway intersection

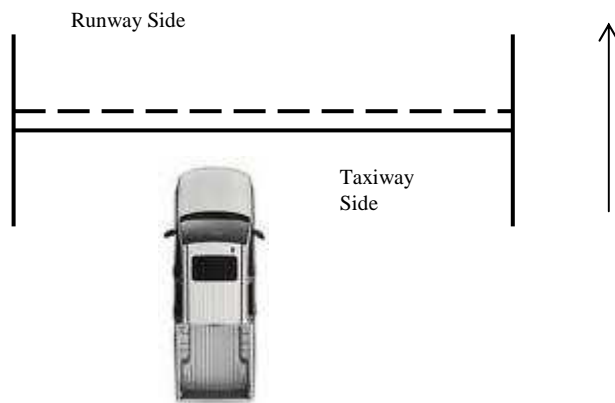

The unbroken line indicates that no vehicle should cross that line without permission sought and approval granted to do so.

The broken line shows that vehicles do not have to seek permission to vacate the runway.

VISUAL AIDS FOR DENOTING RESTRICTED USE AREAS

Closed runways and taxiways, or parts thereof

Application

A closed marking shall be displayed on a runway or taxiway, or portion thereof, which is permanently closed to the use of all aircraft.

Recommendation

A closed marking should be displayed on a temporarily closed runway or taxiway or portion thereof, except that such marking may be omitted when the closing is of short duration and adequate warning by air traffic services is provided.

Location

A closed marking shall be placed at each end of the runway, or portion thereof, declared closed, and additional markings shall be so placed that the maximum interval between markings does not exceed 300 m. On a taxiway a closed marking shall be placed at least at each end of the taxiway or portion thereof closed.

Characteristics

The closed marking shall be of the form and proportions as detailed in Figure 7-1, Illustration a), when displayed on a runway, and shall be of the form and proportions as detailed in Figure 7-1, Illustration b), when displayed on a taxiway. The marking shall be white when displayed on a runway and shall be yellow when displayed on a taxiway.

Note.- When an area is temporarily closed, frangible barriers or markings utilizing materials other than paint or other suitable means may be used to identify the closed area.

When a runway or taxiway or portion thereof is permanently closed, all normal runway and taxiway markings shall be obliterated.

Lighting on a closed runway or taxiway or portion thereof shall not be operated, except as required for maintenance purposes.

In addition to closed markings, when the runway or taxiway or portion thereof closed is intercepted by a usable runway or taxiway that is used at night, un-serviceability lights shall be placed across the entrance to the closed area at intervals not exceeding 3 m (see 7.4.4).

Non-load-bearing surfaces

Application

Shoulders for taxiways, runway turn pads, holding bays and aprons and other non-load bearing surfaces which cannot readily be distinguished from load-bearing surfaces and which, if used by aircraft, might result in damage to the aircraft shall have the boundary between such areas and the load-bearing surface marked by a taxi side stripe marking.

Location

Recommendation

A taxi side stripe marking should be placed along the edge of the load-bearing pavement, with the outer edge of the marking approximately on the edge of the load-bearing pavement.

Characteristics

Recommendation - *A taxi side stripe marking should consist of a pair of solid lines, each 15 cm wide and spaced 15 cm apart and the same colour as the taxiway centre line marking.*

Pre-threshold area

Recommendation

When the surface before a threshold is paved and exceeds 60 m in length and is not suitable for normal use by aircraft, the entire length before the threshold should be marked with a chevron marking.

Location

Recommendation

A chevron marking should point in the direction of the runway and be placed as shown in Figure 7-2.

Non-load-bearing surfaces Cont'd

Recommendation

A chevron marking should be of conspicuous colour and contrast with the colour used for the runway markings; it should preferably be yellow. It should have an overall width of at least 0.9 m.

Unserviceable areas

Application

Un-serviceability markers shall be displayed wherever any portion of a taxiway, apron or holding bay is unfit for the movement of aircraft but it is still possible for aircraft to bypass the area safely. On a movement area used at night, un-serviceability lights shall be used.

Note. - Un-serviceability markers and lights are used for such purposes as warning pilots of a hole in a taxiway or apron pavement or outlining a portion of pavement, such as on an apron, that is under repair. They are not suitable for use when a portion of a runway becomes unserviceable, nor on a taxiway when a major portion of the width becomes unserviceable. In such instances, the runway or taxiway is normally closed.

Location

Un-serviceability markers and lights shall be placed at intervals sufficiently close so as to delineate the unserviceable area.

Characteristics of un-serviceability markers

Un-serviceability markers shall consist of conspicuous upstanding devices such as flags, cones or marker boards.

Characteristics of un-serviceability lights

An un-serviceability light shall consist of a red fixed light. The light shall have intensity sufficient to ensure conspicuity considering the intensity of the adjacent lights and the general level of illumination against which it would normally be viewed. In no case shall the intensity be less than 10 cd of red light.

Characteristics of un-serviceability cones

Recommendation

An un-serviceability cone should be at least 0.5 m in height and red, orange or yellow or any one of these colours in combination with white.

Characteristics of un-serviceability flags

Recommendation - *An un-serviceability flag should be at least 0.5 m square and red, orange or yellow or any one of these colours in combination with white.*

Characteristics of un-serviceability marker boards

Recommendation

An un-serviceability marker board should be at least 0.5 m in height and 0.9 m in length, with alternate red and white or orange and white vertical stripes.

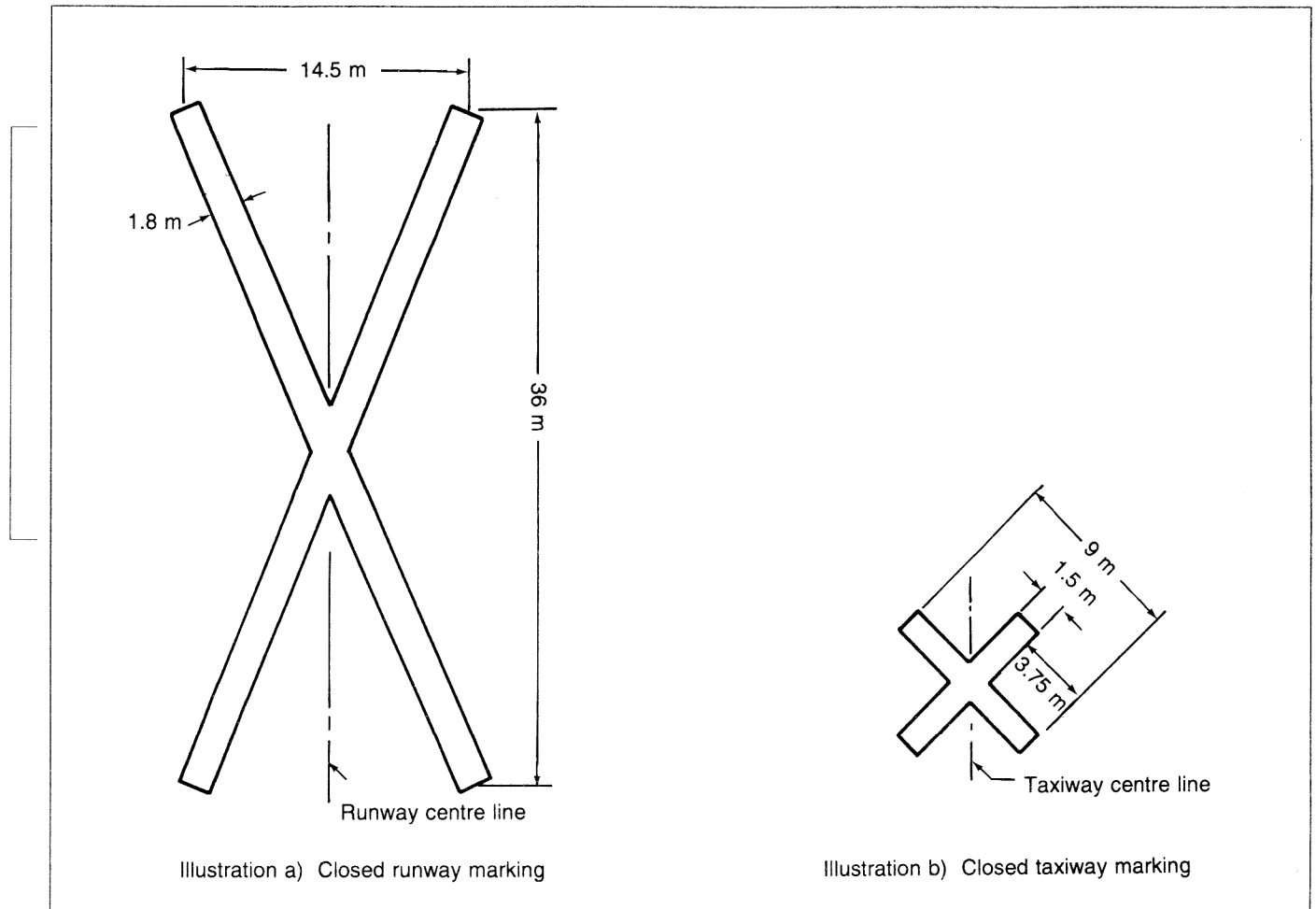

Figure 7-1. Closed runway and taxiway markings

AERODROME ENVIRONMENT FOUR

DEFINITIONS

cd (candela)	The basic unit of luminous intensity (candle power) adopted under the International System of units
Azimuth	An angular distance expressed from the north or south point of the horizon, the horizontal angle or direction of a compass bearing
Precision Approach	A guided approach used for instrument landing

APPROVED AERONAUTICAL LIGHTS

Aeronautical Ground Light: any light specifically provided as an aid to air navigation, other than a light displayed on an aircraft

Runway Edge Lights: runway edge lights shall be provided for a runway intended to be use at night or for a precision approach runway intended for use by day or night.

- Runway edge lights shall be placed along the full length of the runway and shall be parallel rows equidistant from the centre line
- Runway edge lights shall be spaced at intervals of no greater than 60metres for instrument runways and no greater than 100metres for non instrument runways
- Runway edge lights shall be fixed variable white except: -
 - From the approach end between the beginning of the runway and the displaced threshold shall be red lights; and
 - The last third of the runway may show yellow

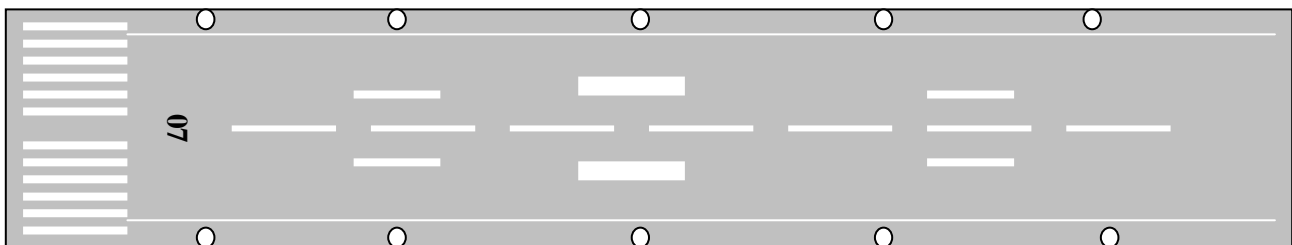

Runway Threshold Lights

- Runway threshold lights shall be provided for a runway equipped with runway edge lights except for a non-instrument or non-precision approach runway where the threshold is displaced.

- For a normal threshold the lights shall be placed in a row at right angles to the runway axis as near as possible to the extremity of the runway
- For a displaced threshold the lights shall be placed in a row at right angles to the runway axis at the displaced threshold
- Threshold lights shall be unidirectional showing green in the direction of approach to the runway

For Non-instrument (at least 6 lights)

Normal Threshold

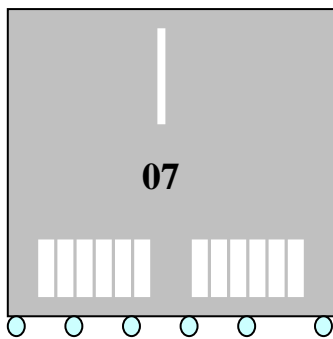

OR

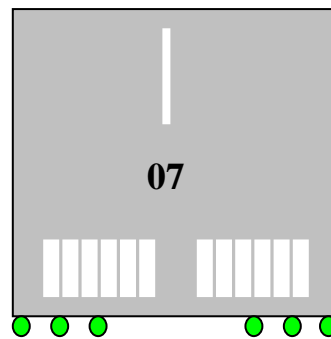

Displaced Threshold

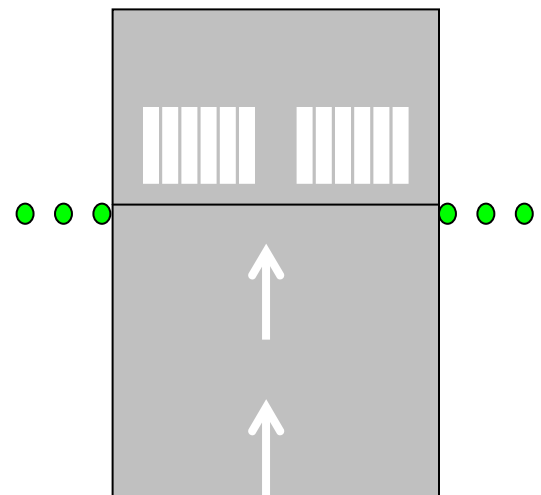
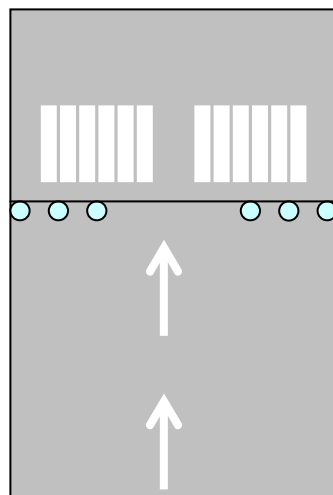
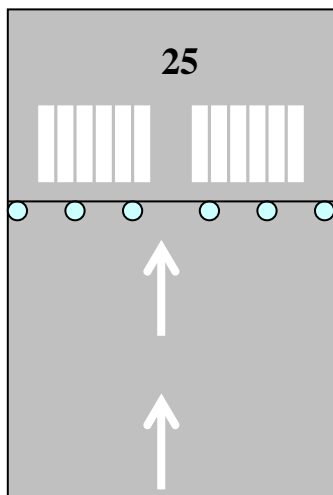

For Precision Approach Runways (Varies with category)

- The same principle applies for normal and displaced threshold as per non-instrument runways except that there are at least sixteen (16) lights across the width of the runway and at least five (5) when placed on either side of the threshold

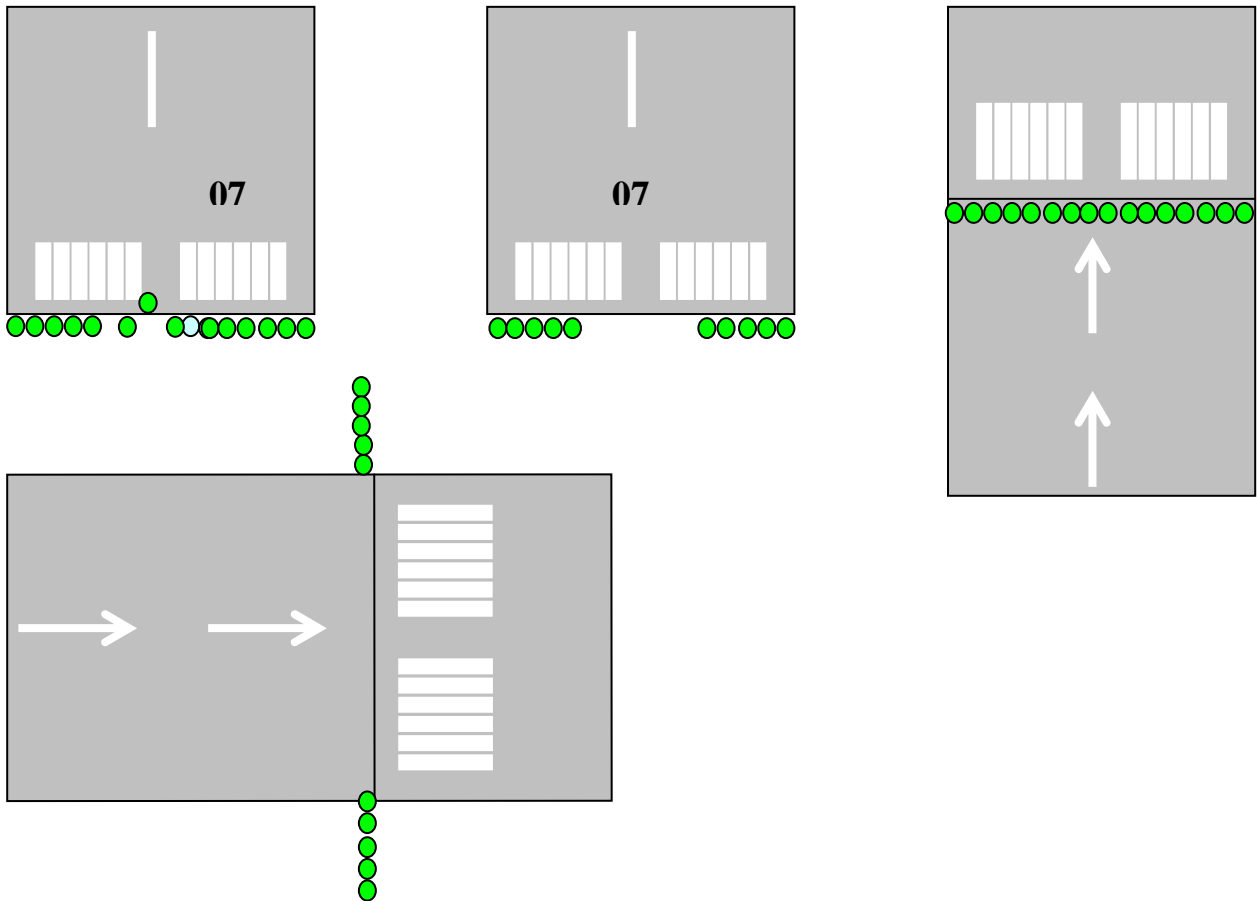

Runway End Lights

- Runway end lights shall be provided for a runway equipped with edge lights
- Runway end lights shall be at least six (6) placed on a line at right angles to the runway axis as near to the end of the runway as possible
- Runway end lights should be fixed unidirectional showing red in the direction of the runway
- If the threshold and end lights are co-incident then combined bi-directional lights are used

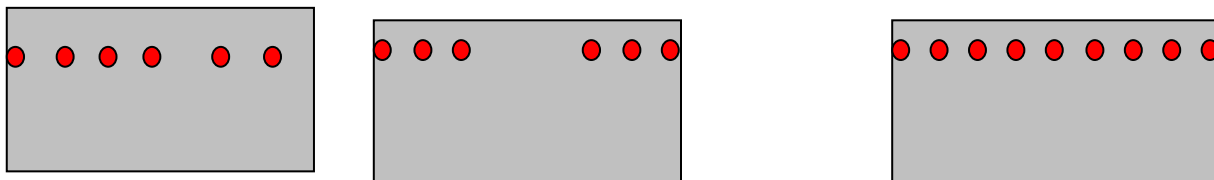

Runway Centerline and Touchdown Zone Lights

- Runway Centerline lights shall be provided for a runway intended to be used for take off with RVR (Runway Visual Range) of less than 400 meters
- Runway Centerline lights shall be located along the centerline of the runway or offset to one side of the centerline by no more than 60 centimeters, placed between 15 and 30 meters apart
- Runway Centerline lights shall be fixed showing variable white from the threshold up to 900 meters from the end of the runway; then alternate red and white between 900 and 300 meters from the end; then red from 300 meters to the end of the runway
- Runway Touchdown Zone lights shall be provided for a precision approach runway categories II and III
- Runway Touchdown Zone lights shall be fixed unidirectional showing variable white

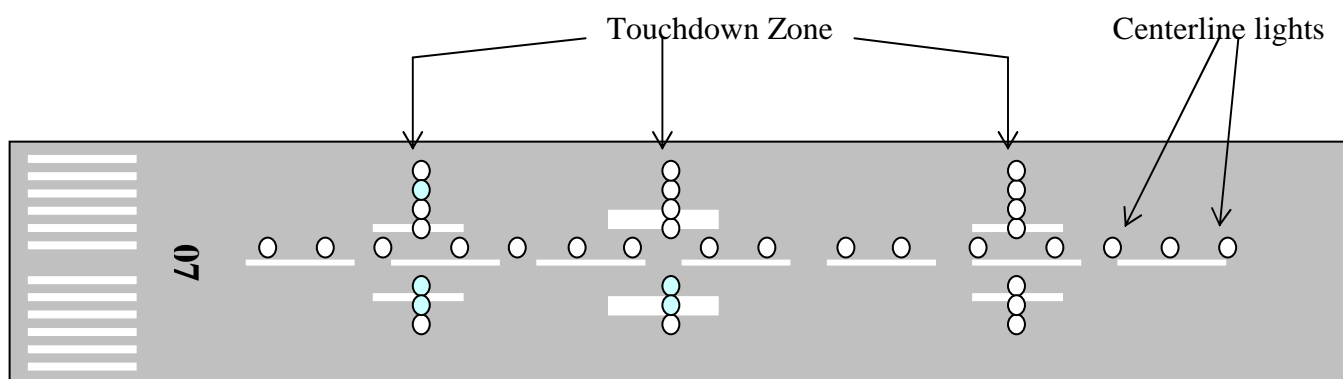

Stopway Lights

- Stopway lights shall be provided for a stopway intended for use at night
- Stopway lights shall be fixed unidirectional showing red in the direction of the runway

Taxiway Lights

- Taxiway lighting shall be blue edge lights or green centerline lights, or both.
- Taxiway lights shall be shown in all direction to provide guidance to a pilot taxiing in either direction
- At an intersection, exit or curve, the lights shall be shielded as far as practicable so that they cannot be confused with other lights

- Holding points are marked by a yellow light on either side, or a single light on the centerline

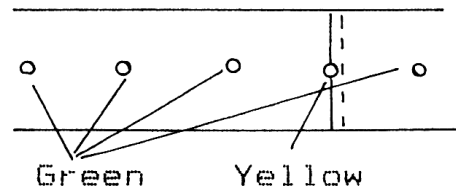
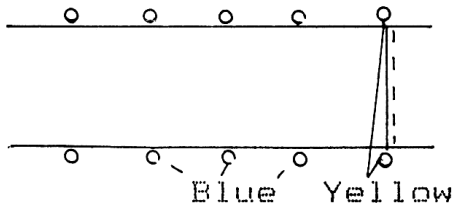

Approach Lighting

A) Simple Approach Lighting (For Non-precision Runways)

- A row of lights on the extended centerline of the runway for a distance of not less than 420 meters from the threshold, spaced at 30-60 meters apart; and another row of lights forming a crossbar 18 to 30 meters long, 300 meters from the threshold
- Fixed lights with colour (usually red or white) to ensure that it is readily distinguishable from other aeronautical ground lights

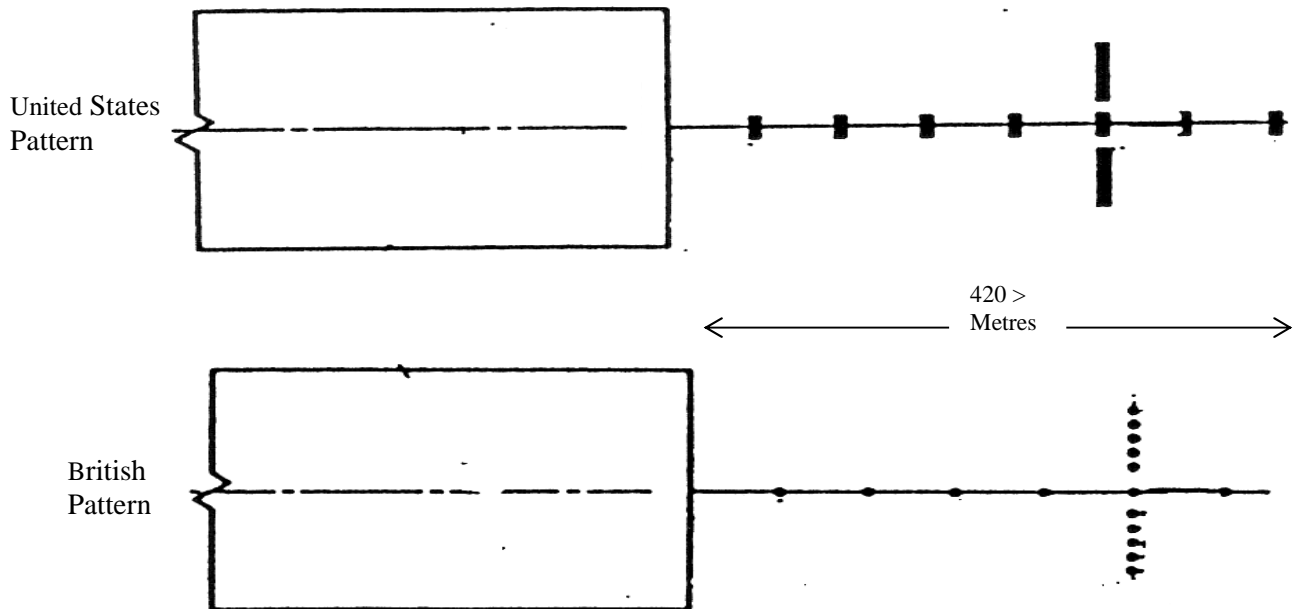

B) Precision Approach Lighting Category I

- Either of the patterns below:-

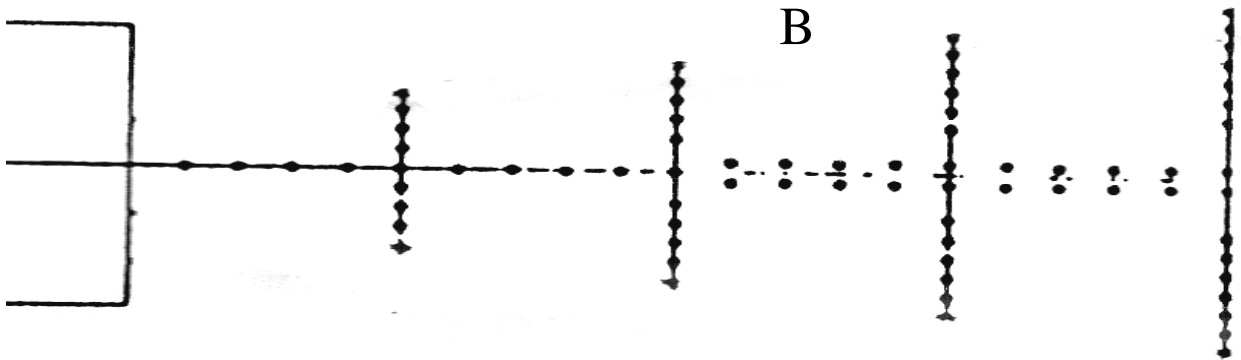
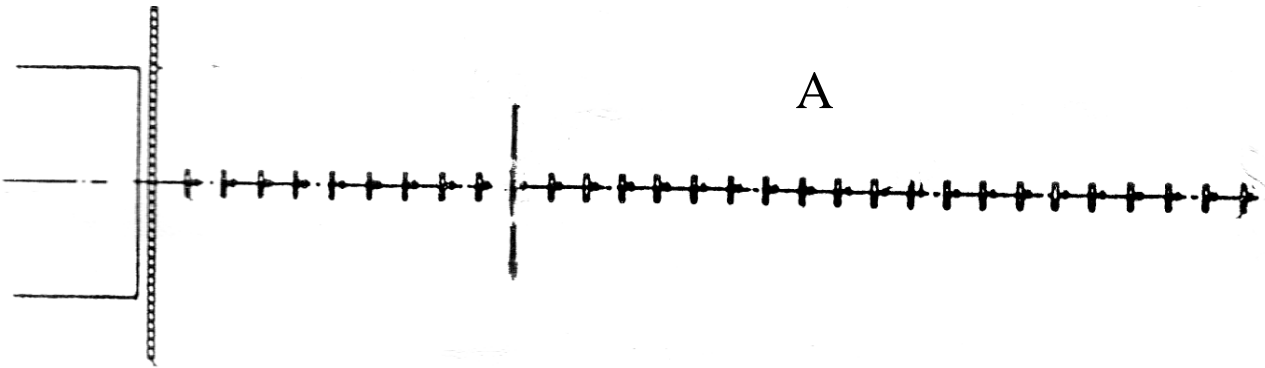

B) Precision Approach Category II and III

- Barrettes as in "A" above may be used before 'X'

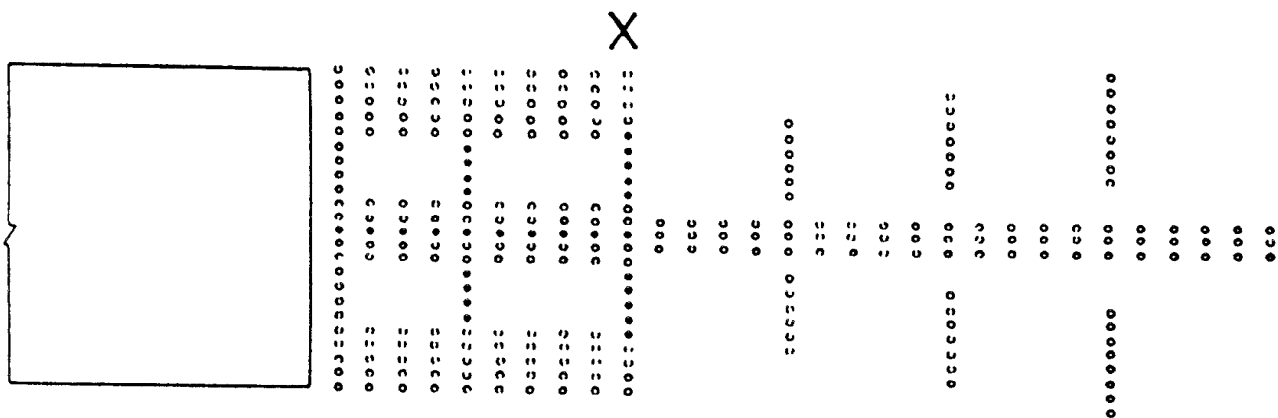

Visual Approach Slope Indicator Systems

- Visual Approach Slope Indicator Systems include:-
 - T-VASIS and AT-VASIS; and
 - PAPI and APAPI
- A Visual Approach Slope Indicator System shall be provided to serve the approach to a runway whether or not the runway is served by other visual approach aids or non-visual aids where one or more exits
 - The runway is used for turbo-jets or other type aircraft requiring similar approach guidance assistance
 - The pilot of any type airplane may have difficulty in judging the approach
 - The presence of objects in the approach area that would present hazards if the aircraft descends below normal approach path
 - Physical conditions at either ends of the runway that would present hazards if the aircraft undershoots or overshoots the runway
 - Terrain or prevalent MET conditions are such that an airplane may be subject to unusual turbulence during approach.

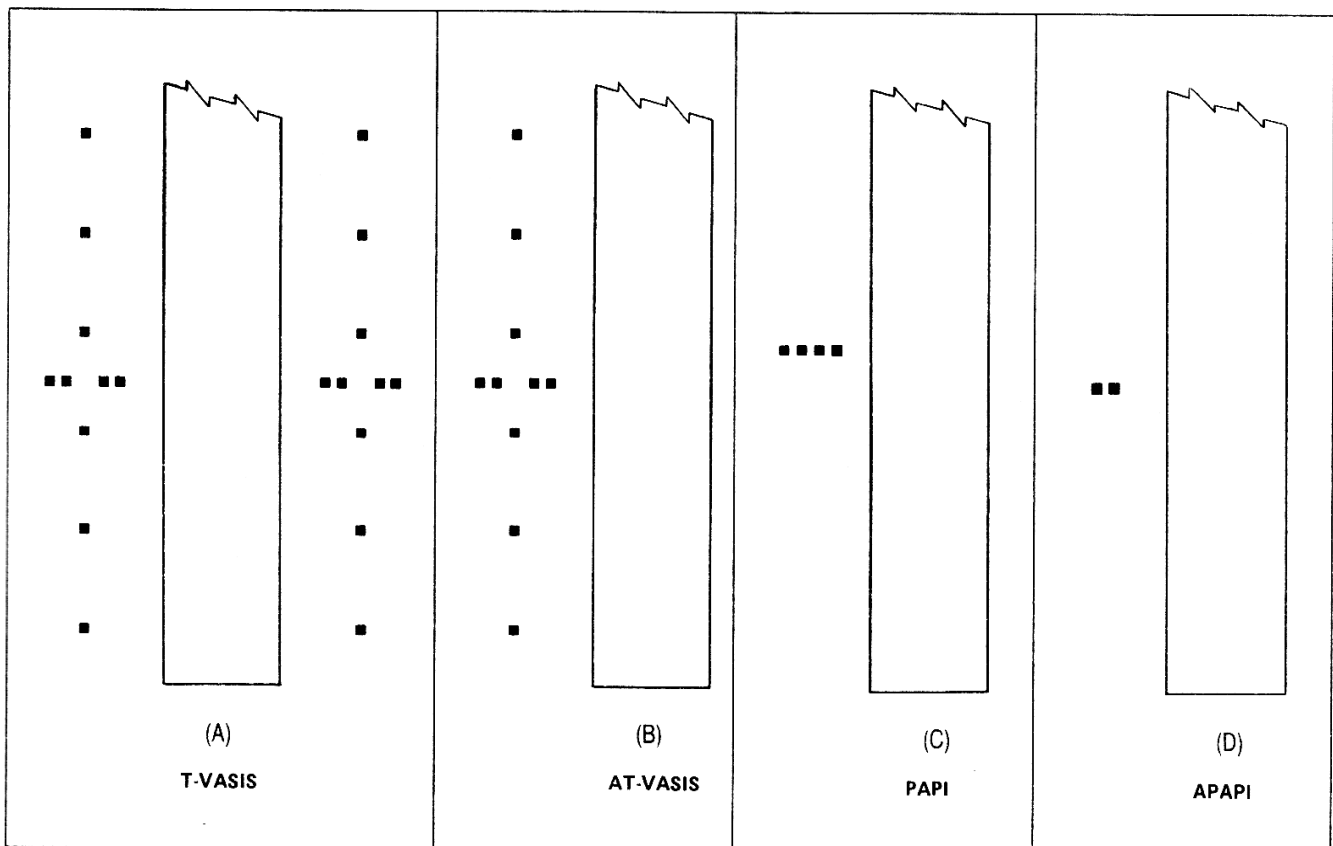

Aerodrome Beacon

- An aerodrome beacon shall be provided at an aerodrome intended for use at night if one or more of the following exist:-
 - Aircraft navigate predominantly by visual means
 - Reduced visibility are frequent
 - It is difficult to locate the aerodrome by air due to surrounding lights or terrain
- An aerodrome beacon shall be located on or adjacent to the aerodrome in area of low ambient background and shall be either coloured flashes alternating with white flashes or white flashes only flashing
- The light shall show in all angles, flashing 20-30 per minute, with intensity of and not less than 2,000 cd

Aerodrome Identification Beacon

- An aerodrome identification beacon shall be provided at an aerodrome intended for use at night that cannot be easily identified from the air or otherwise
- An aerodrome identification beacon shall be located on the aerodrome in area of low ambient background lighting
- The light shall show in all angles azimuth, flashing green at a land aerodrome and yellow at a water aerodrome, transmitting the aerodrome identification characters in international Morse Code, with intensity of not less than 2,000cd

Light Mountings

- Aeronautical ground lights may be elevated or inset in the surface. Elevated lights must be frangible and low enough to preserve clearance from aircraft. Surface lights shall be able to withstand being rolled over by aircraft wheels without damage to lights or aircraft

Light Intensity Control

- Intensity controls shall be provided to allow for adjustments to meet prevailing conditions for the following lighting systems:-
 - Approach lights
 - Runway edge lights
 - Runway threshold lights
 - Runway end lights
 - Runway centerline lights
 - Runway touchdown zone lights
 - Taxiway centerline lights

Local Operation of Aerodrome Lighting

- In general lighting shall be operated:-
 - At nights or during bad weather (IFR conditions)
 - At pilots request
 - When they may aid aircraft known or believed to be in need of assistance

Intensity Settings

- Adjust lighting intensity in accordance with local directives or at pilot's request

Aerodrome Markings and Lighting

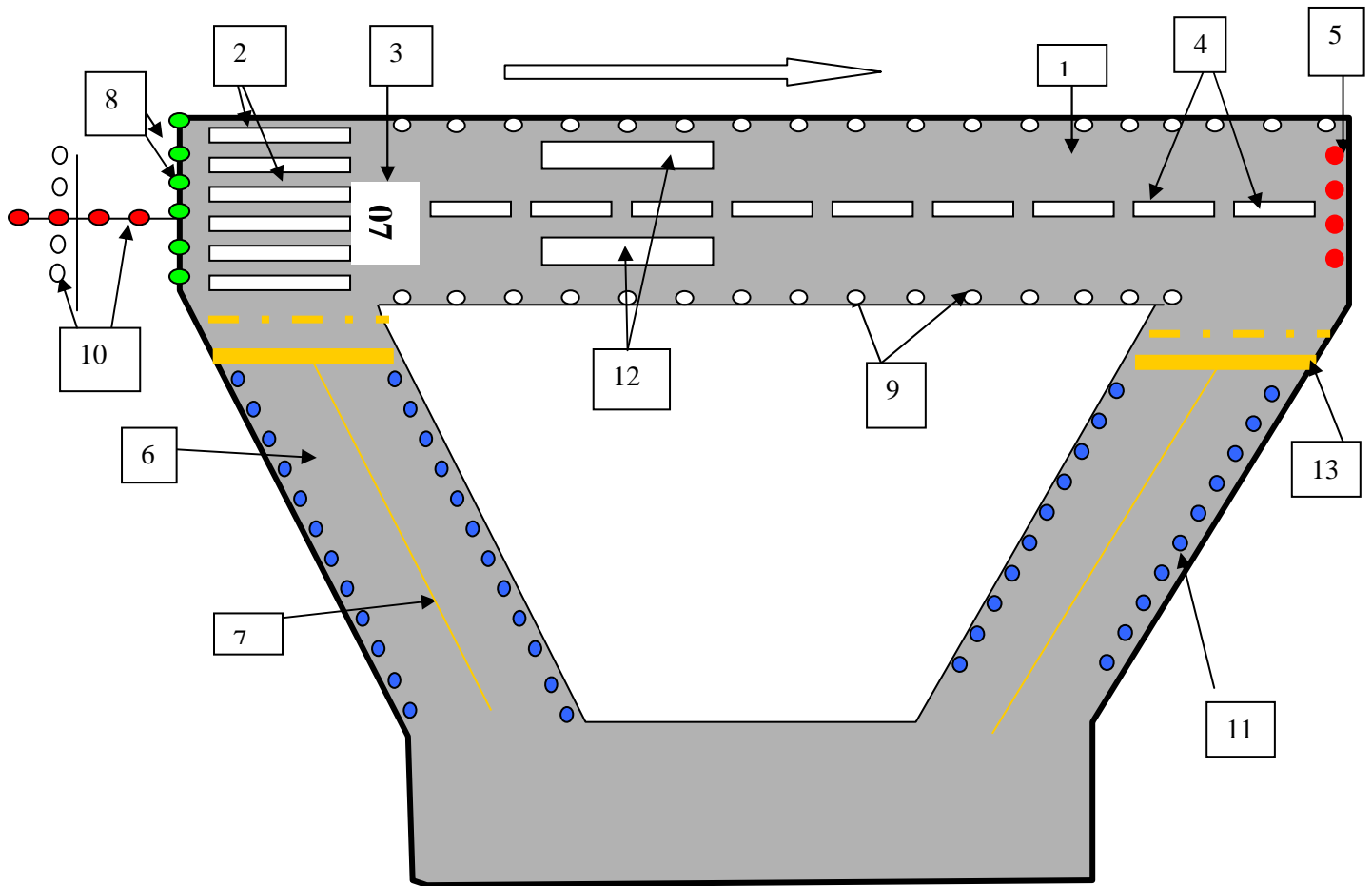

Key	Description	Colour
1	Runway	
2	Runway Threshold Marking	White
3	Runway Number Marking	White
4	Runway Centerline Marking	White
5	Runway End Light	Red
6	Taxiway	
7	Taxiway Guideline/Centerline Marking	Yellow
8	Runway Threshold Lighting	Green
9	Runway Edge Lighting	White
10	Approach Lighting	Red or White
11	Taxiway Edge Lighting	Blue
12	Touchdown Zone Markings	White
13	Holding Point Marking	Yellow

AERODROME ENVIRONMENT FIVE

OBJECTS WITHIN SPECIFIED AREAS & VISUAL AIDS TO LANDING

General

- No object, unless required for air navigation purposes is permitted:-
 - On a runway strip,
 - In a runway end safety area,
 - In a taxiway strip or within the distances specified in Annex 14, if it would endanger an aircraft
 - On a clearway, if it would endanger an aircraft in the air.
- An object required for air navigation purposes and which is situated on the strip within the distances specified in Annex 14, or which penetrates the surfaces specified in Annex 14, shall be of minimum practicable mass, meets the frangibility requirements and be sited so as to reduce the hazard to a minimum.

Local Application

- At Sangster airport, objects other than those permissible as indicated in the relevant sections of Annex 14 which are within less than **75 m** of the runway centre line and 45 m of the centre line of a taxiway (other than taxi lane centre line) are considered as obstacles.
- Any object which may endanger aircraft on the movement area or in the air whether fixed or mobile should, as far as practicable be removed.

Objects to be marked and/or lit

- The marking and/or lighting of obstacles is intended to reduce hazards to aircraft by indicating the presence of the obstacles. It does not necessarily reduce operating limitations that may be imposed by an obstacle.
- All fixed obstacles shall be marked by the appropriate colours, but if this is not practicable, markers or flags shall be displayed on or above them.
- All mobile obstacles shall be marked by, or shall display flags of the appropriate colours.

Objects to be marker and/or lit Cont'd

- The appropriate colours are orange and white, or red and white arranged in patterns as indicated below

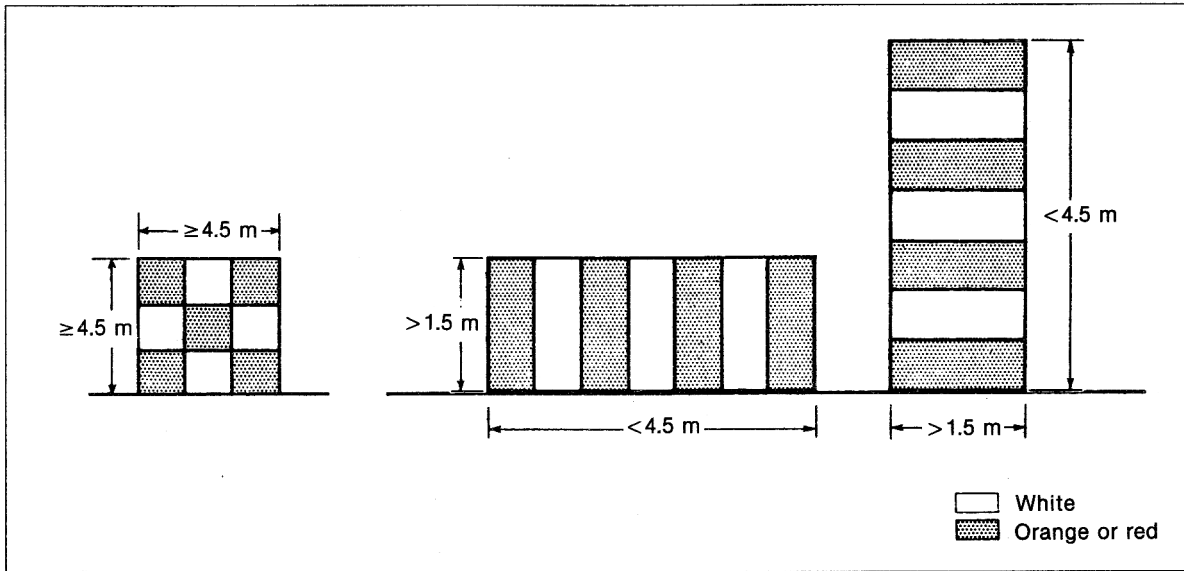

Basic Marking Patterns

Lighting of Objects

- Obstacles that must be lit shall be indicated by LOW, MEDIUM or HIGH-Intensity obstacle lights

A) Low-intensity Lights

- Low-intensity obstacle lights are used where it is considered that such intensity is sufficient to ensure conspicuity when view against the intensity of adjacent lights and the general level of the surrounding illumination. Low-intensity obstacle lights shall never be less than 10cd (candela or candlepower)
- Low-intensity obstacle lights on fixed objects shall be steady (fixed) red lights. Low-intensity lights on mobile objects shall be flashing lights - either red or, preferably, yellow, between 60 and 90 per minute and no less than 40cd. (Candela)

B) Medium-intensity Lights

- Where low-intensity obstacle lights would be inadequate or where a special early warning is required, medium or high intensity obstacle lights should be used. Where the object is an extensive one or its height is greater than 45m, then medium-intensity obstacle lights should be used, either alone or in combination with low-intensity lights. (A group of trees or buildings is regarded as an extensive object)

Medium-intensity Lights Cont'd

- Medium-intensity obstacle lights shall be flashing red lights, between 20 and 60 per minute and no less than 1,600cd.
- When medium-intensity obstacle lights are used in conjunction with high-intensity obstacle lights, then they shall be white, conforming to the colour of the high intensity lights.
- Low and Medium intensity lights are intended for night operation only
- High-intensity lights are intended for day as well as night operation

C) High-intensity Lights

- High-intensity lights are used to indicate the presence of: -
 - a) An Obstacle of more than 150m high
 - b) A tower supporting overhead wires, cables, etc. where: -
 - Such lights are necessary for the recognition of the presence of such wires, cables, etc. by day; or
 - It has not been practicable to install markers on the wires, cables, etc.
- High-intensity lights should be white flashing lights, the intensity and frequency varying with usage.

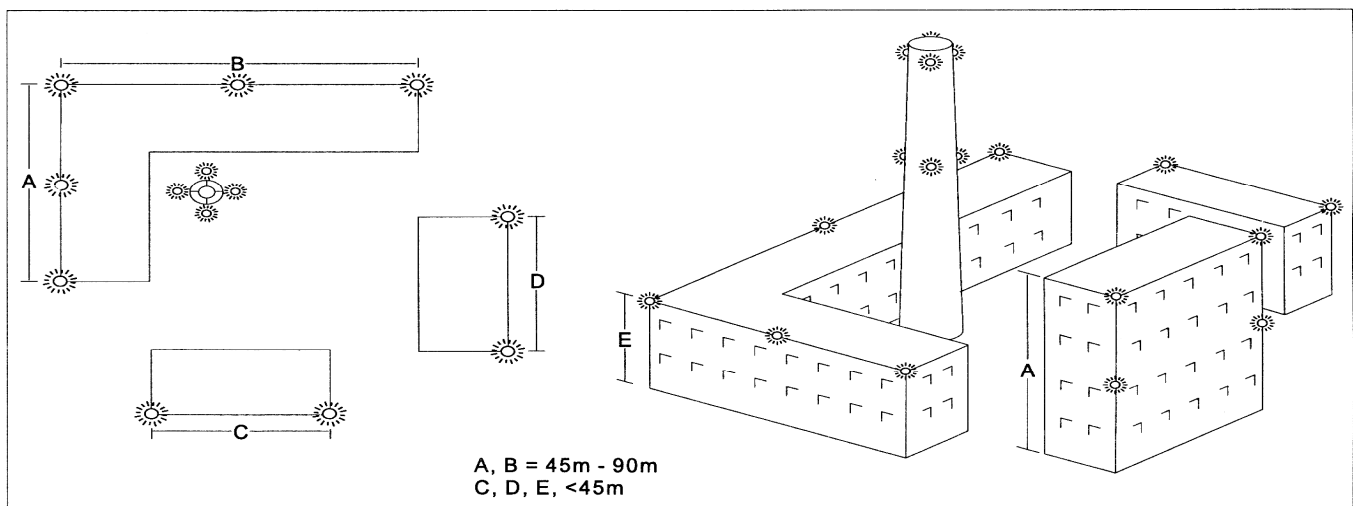
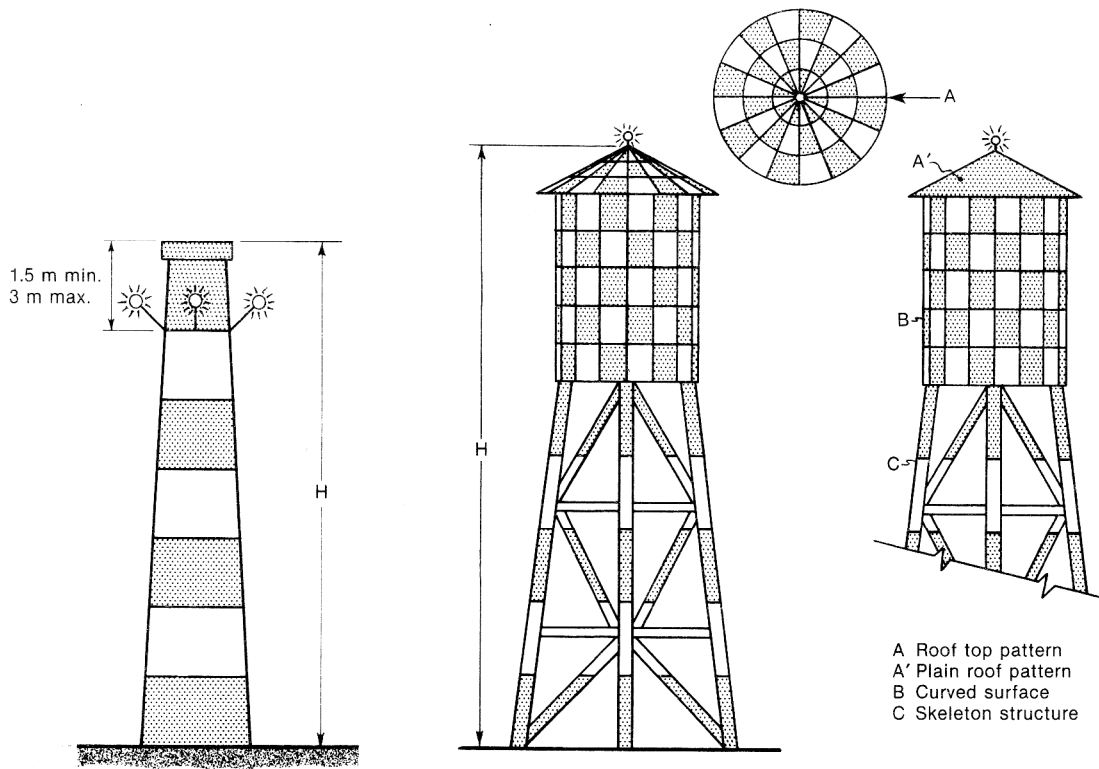
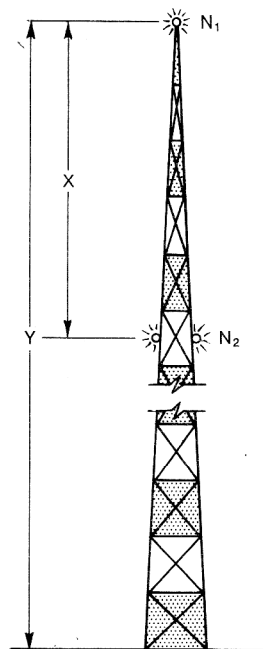

Figure 6-3. Lighting of buildings



Note.— *H* is less the 45 m for the examples shown above.
For greater heights intermediate lights must be added as shown below.



$$\text{Number of lights} = N = \frac{Y \text{ (metres)}}{45}$$

$$\text{Light spacing} = X = \frac{Y}{N} \leq 45 \text{ m}$$

Figure 6-2. Examples of marking and lighting of tall structures

Visual Aids to Landing

A) Wind Direction Indicators

- An aerodrome shall be equipped with at least one wind direction indicator (Wind Sock)
- The WDI/Wind Sock shall be located so as to be visible from aircraft in flight or on the movement area



B) Landing Direction Indicator

- Where provided, a Landing Direction Indicator shall be located in a conspicuous area on the aerodrome
- The Landing Direction Indicator shall be in the form of a "T" as indicated below its shaft being oriented toward the runway in use

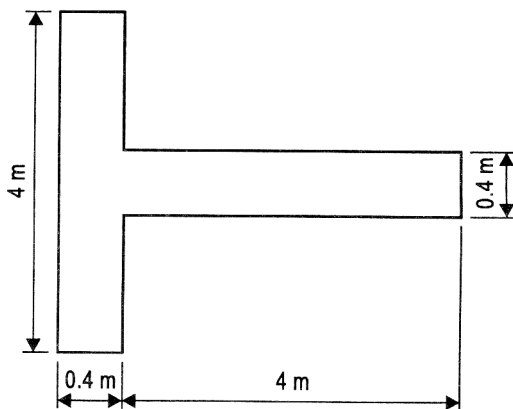

AERODROME ENVIRONMENT SIX

Movement on the Manoeuvring Area

The movements of aircraft, personnel and vehicles on the manoeuvring area and the movement of aircraft on the apron(s) are at all times subject to permission from aerodrome control. Ground control's responsibility on the apron(s) is limited to providing instruction and advice to assist in:

- (1) the prevention of collisions between moving aircraft and other aircraft on the ground,
- (2) between aircraft and vehicles given permission to operate on the manoeuvring area.

Ground control does not normally exercise control over the movement of personnel and vehicles on the apron(s). The movement of aircraft, personnel and vehicles on the manoeuvring area is controlled by radio or light signals.

Under no circumstances should any vehicle be driven on the Taxiway or Runway without the permission of the Air Traffic Control. Furthermore, the driver of such vehicle should be in radio contact with the control Tower and the checkered orange and white aviation flag should be displayed on the vehicle.

No person at an airport with an operating Control Tower shall operate a motor vehicle beyond the bars of an active runway or closer than 75m from the active runway centre line, or closer than 45m from the centre line of an active taxiway, or as may subsequently be required by regulations, without first having received clearance from the control Tower to Proceed.

The operator of a motor vehicle requiring clearance to operate on or across an active runway at Sangster International airport where an Air Traffic Control Tower is active, shall maintain direct two-way radio contact with the control Tower, or in the event a two-way radio is inoperable or unavailable, shall operate said vehicle only under the escort of an authorised motor vehicle equipped with a two-way radio in contact with the Control Tower.

This requirement shall not apply, however, to operators of vehicles authorised by MBJ Airports Limited to receive pre-established visual signals from the Control Tower, or to operators of vehicles following pre-established special procedures of MBJ which have been approved by the Jamaica Civil Aviation Authority (JCAA).

The pre-established visual signals from the Control Tower are shown to the vehicle using a signaling Lamp

Signaling Lamp

- A Signaling lamp shall be provided at a controlled aerodrome in the control tower which should be capable of producing red, green and white signals



Signaling Lamp

Usage

- When radio communication cannot be employed, ATC light signals are used to control the movements of aircraft operating in the air and on the movement area, as well as vehicles and personnel operating on the maneuvering area.
- In conditions of low visibility where the movement of non-radio aircraft and vehicles cannot be controlled by light signals, the operation on the maneuvering area of all vehicles except for emergency vehicles should normally be prohibited.
- If all other forms of communication fail, the flashing on and off RWY lights may be used to signal vehicles and personnel to vacate active runway.

Signal Area

- A Signal Area is provided only when it is necessary to use visual ground signals to communicate with aircraft in flight, when:
 - ⌘ The aerodrome does not have an Aerodrome Control Tower
 - ⌘ The aerodrome does not have Aerodrome Flight Information Service Unit
 - ⌘ The aerodrome is used by aircraft not equipped with radio

The table below gives the meaning of ATC light signals

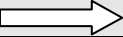
SIGNALS	MEANING
Application 	Vehicles, equipment & personnel
STEADY GREEN	Cleared to cross, proceed, Go
FLASHING GREEN	Not applicable
STEADY RED	Stop
FLASHING RED	Clear the RWY/ TWY
FLASHING WHITE	Return to starting point on the aerodrome
ALTERNATING RED & GREEN	Exercise extreme caution

AERODROME OPERATIONS TWO

SAFETY REQUIREMENTS FOR VEHICLE AND EQUIPMENT

It is very important that the vehicles used on the airfield conform to safety restriction outlined in the Operational Directives & Tenants Obligations handbook. In this chapter we will look at some of the rules as they apply to vehicle operation

No person shall operate a motor vehicle or equipment on the aerodrome unless such vehicle or equipment is in good operating condition and is equipped with at least the following safety equipment in fully operable condition:

- (a) Motor Vehicle Lights
- (b) Motor Vehicle Brakes
- (c) Motor Vehicle windows and mirrors

Motor Vehicle Lights

All motor vehicles operated on the aerodrome, except motor designed for only one headlight, shall be equipped with two headlights and one or more red tail lights and brake lights. Exceptions: Tow tugs, and other specialized ramp units, which are standard, equipped with taillights only. For general guidelines, vehicles with four (4) wheels shall required dual headlights.

All headlights and tail lights shall be kept lit between the hours of sunset and sunrise when the vehicle is in use, and at all times when passing through unlit or poorly lit areas during poor visibility.

All motor vehicles, other than emergency vehicles, operating on runways and taxiways of the aerodrome shall display amber overhead flashing or rotating light at all times while so operating. Provided, however, that between the hours of sunrise and sunset a motor vehicle displays a checkered flag approved by MBJ. The use of red or blue flashing lights shall be limited to emergency vehicles only.

All motor vehicle lights shall be of sufficient brilliance to assure safety in driving.

Motor Vehicle Brakes

All motor vehicles operating on the aerodrome shall be equipped with a properly functioning braking system, suitable for the specific type of equipment operated

The operator of a motor vehicle on the aerodrome shall test the brakes of such vehicle upon approaching an aircraft within such distance as necessary to avoid a collision with such aircraft in the event of a brake failure.

Motor Vehicle windows and mirrors

Every motor vehicle operating on the aerodrome shall be equipped with at least one mirror, so adjusted that the operator of such vehicle shall have a clear view of the road behind for a distance of at least 200ft (60.61m). Exceptions to requirement are to be requested through the Airside Operations Manager or his designated representative, and if justified, authorization will be granted on an individual basis.

The windshield and other windows of a motor vehicle operating on the aerodrome shall be free of cracks, blisters, discoloration or any other defect causing distortion or obstruction of the vision of the operator thereof.

The use or placing of posters, stickers, signs or other objects on the windshield or other windows of a motor vehicle operation on the aerodrome other than those required by MBJ or by Road Traffic Law, is prohibited.

The vision of the operator of a motor vehicle on the aerodrome shall not be obstructed by an extended super-structure or load.

Any persons operating a motor vehicle on the aerodrome shall obey all posted regulatory signs, special signs, pavement markings and traffic signs, and all instructions by the control Tower, or by an Airside operations agent or airport Security officer.

It shall be the duty of a driver of a motor vehicle to take such action as may be necessary to avoid an accident, and the breach by a driver of any motor vehicle.

Traffic of persons and vehicles on aerodromes

The grounds of each aerodrome are divided into two zones

- a) a public zone comprising the part of the aerodrome open to the public; and
- b) a restricted zone comprising the rest of the aerodrome

Movement of persons

Access to the restricted zone is authorised only under the conditions prescribed by the special rules governing the aerodrome. The custom, police and health inspection offices and the premises assigned to transit traffic are normally accessible only to passengers, to staff of the public authorities and airlines and to authorised persons in pursuit of their duty. The movement of persons having access to the restricted zone of the aerodrome is subject to the conditions prescribed by the air navigation regulations and by the special rules laid down by the aerodrome administration.

Movement of vehicles

The movement of vehicles in the restricted zone is strictly limited to vehicles driven or used by persons carrying an Airside Vehicle Operator Permit or an official card of admittance. Drivers of vehicles, of whatever type, operating within the confines of the aerodrome must respect the direction of the traffic, the traffic signs and the posted speed limits and generally comply with the provisions of the Highway Code and with the instructions given by MBJ.